

Schnittzeichnungen BetteFloor mit Einbausystem Basic

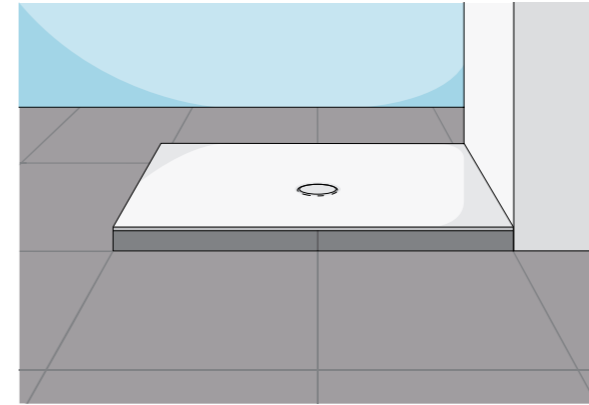
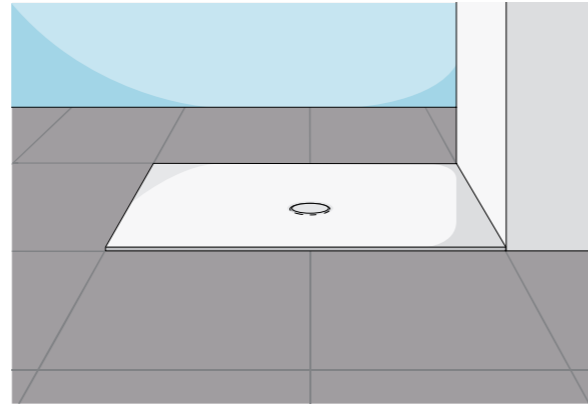
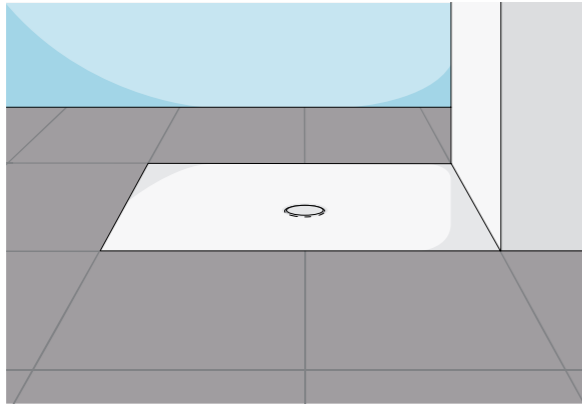

Ablaufgarnitur Bodengleicher Einbau

BetteSolid 50

B598-
0,6 l/s
mit seitlicher
Entwässerung,
Sperrwasserhöhe 50 mm
gem. EN 274

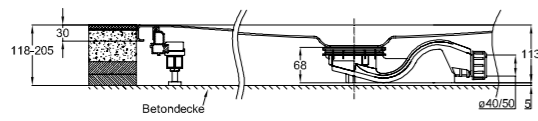

Nahezu bodengleicher Einbau

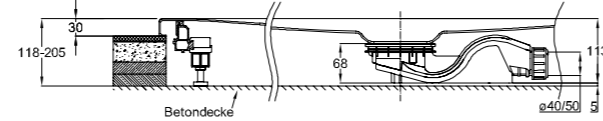

Einbau mit Fliesensockel aus dem Boden

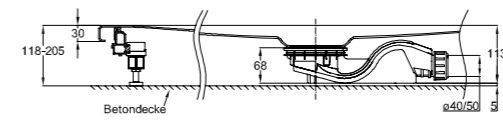

BetteSolid 30

B597-
0,6 l/s
mit seitlicher
Entwässerung,
Sperrwasserhöhe 30 mm
gem. EN 274

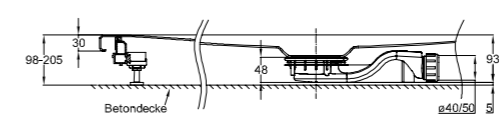
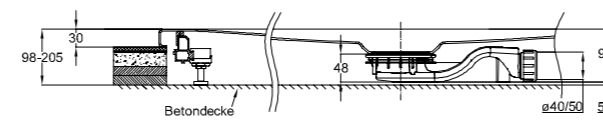
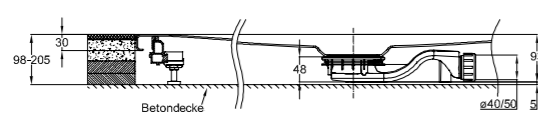

BetteScope

B574-
0,85 l/s
mit seitlicher
Entwässerung,
Sperrwasserhöhe 50 mm
gem. EN 274

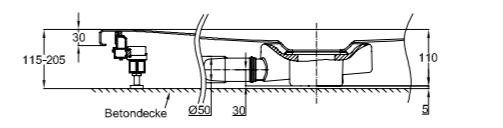
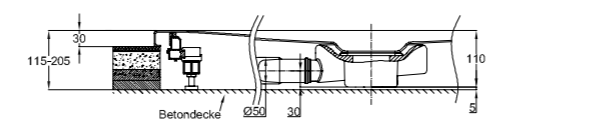
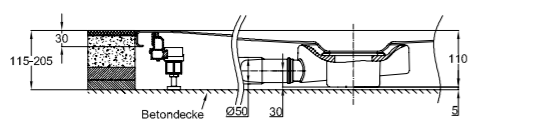

BetteDown

B594-
0,6 l/s
mit senkrechter
Entwässerung,
Sperrwasserhöhe 50 mm
gem. EN 274

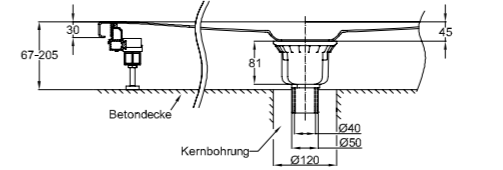
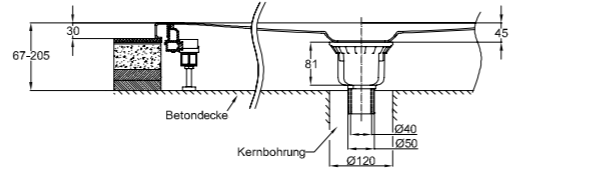
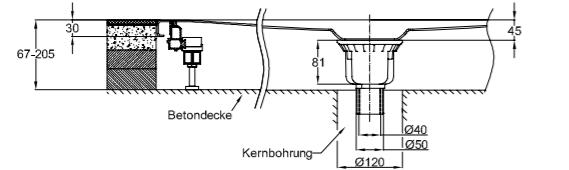

Schnittzeichnungen

BetteFloor Side mit Einbausystem Basic

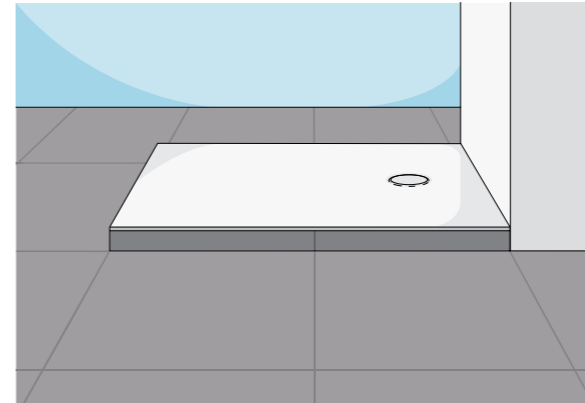
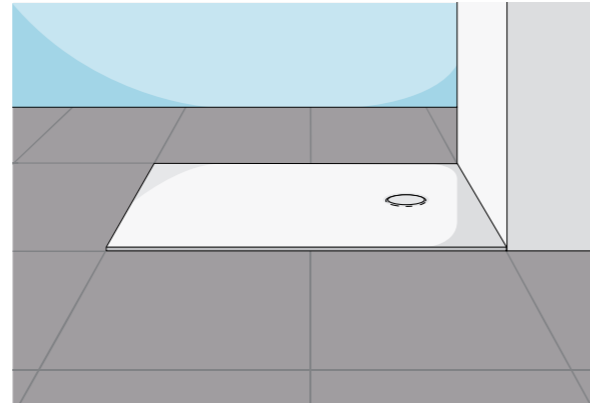
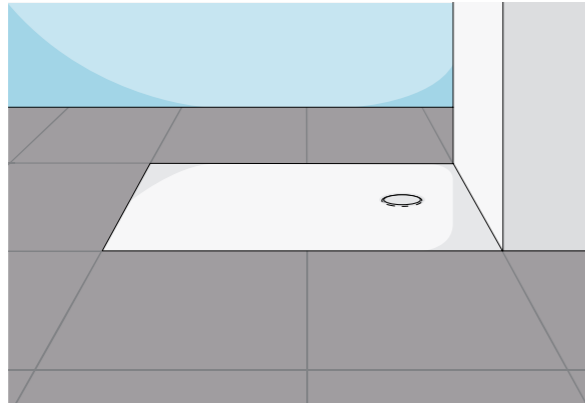

Ablaufgarnitur

BetteSolid 50

B598-^{*}
0,6 l/s
mit seitlicher
Entwässerung,
Sperrwasserhöhe 50 mm
gem. EN 274

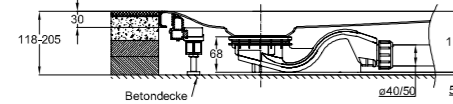

Nahezu bodengleicher Einbau

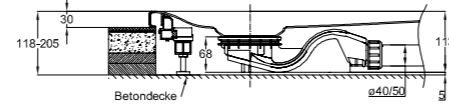

Einbau mit Fliesensockel aus dem Boden

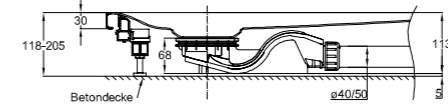

BetteSolid 30

B597-^{*}
0,6 l/s
mit seitlicher
Entwässerung,
Sperrwasserhöhe 30 mm

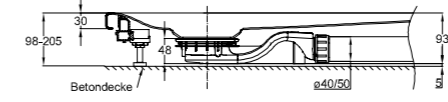
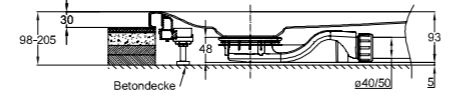
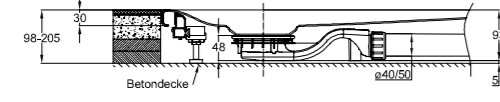

BetteScope

B574-^{*}
0,85 l/s
mit seitlicher
Entwässerung,
Sperrwasserhöhe 50 mm
gem. EN 274

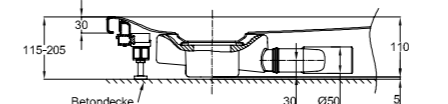
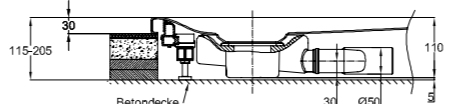
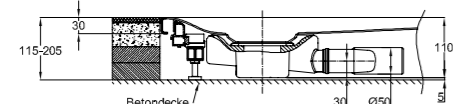

BetteDown

B595-^{*}
0,6 l/s
mit senkrechter
Entwässerung,
Sperrwasserhöhe 50 mm
gem. EN 274

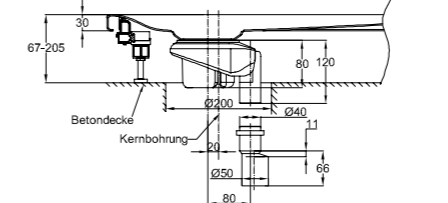
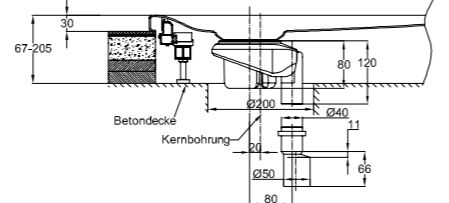
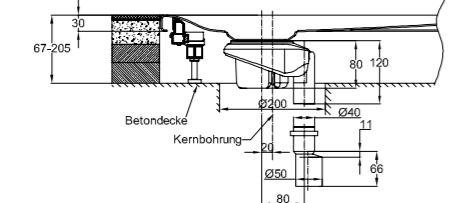

Schnittzeichnungen

BetteUltra 25 mm mit Einbausystem Basic

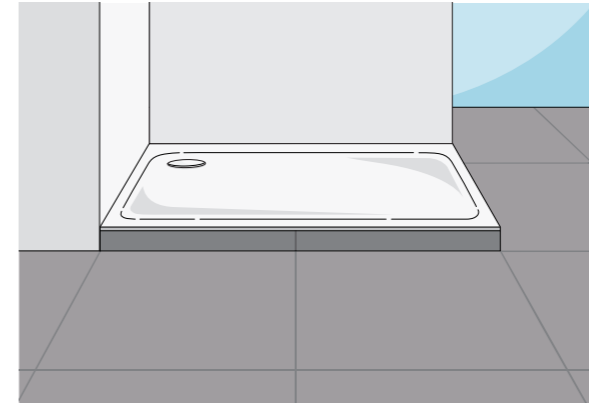
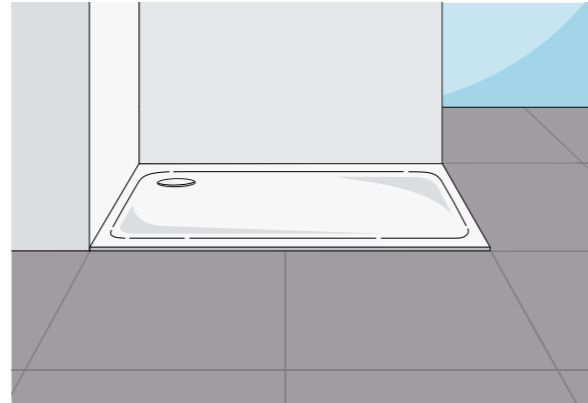
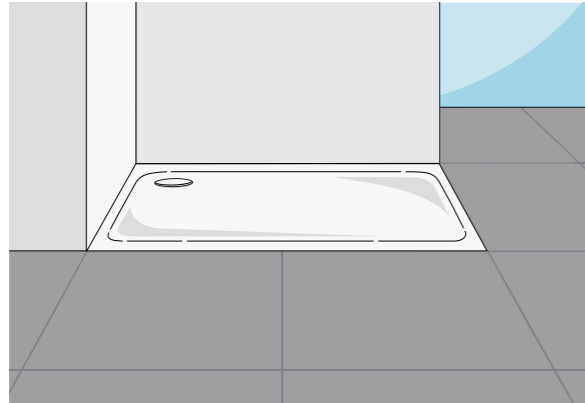

Ablaufgarnitur Bodengleicher Einbau

BetteSolid 50

B598-
0,6 l/s
mit seitlicher
Entwässerung,
Sperrwasserhöhe 50 mm
gem. EN 274

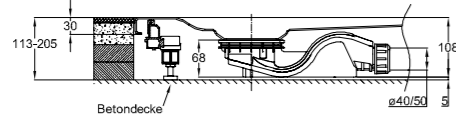

Nahezu bodengleicher Einbau

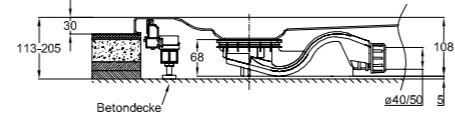

Einbau mit Fliesensockel aus dem Boden

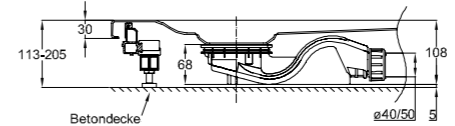

BetteSolid 30

B597-
0,6 l/s
mit seitlicher
Entwässerung,
Sperrwasserhöhe 30 mm
gem. EN 274

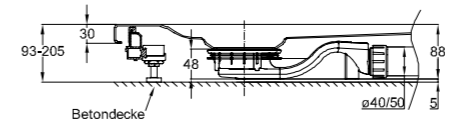
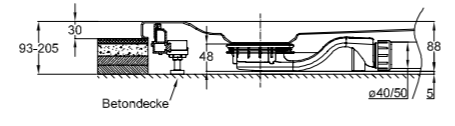
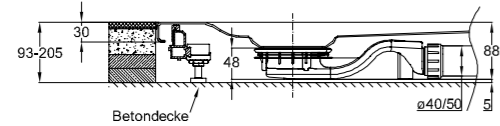

BetteScope

B574-
0,85 l/s
mit seitlicher
Entwässerung,
Sperrwasserhöhe 50 mm
gem. EN 274

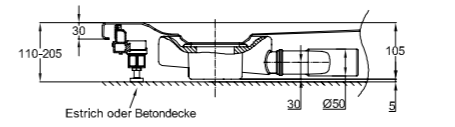
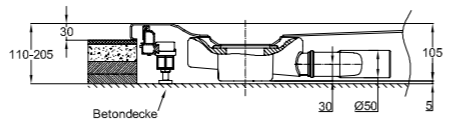
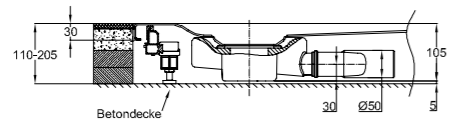

BetteDown

B594-
0,6 l/s
mit senkrechter
Entwässerung,
Sperrwasserhöhe 50 mm
gem. EN 274

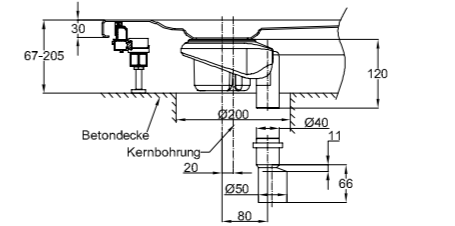
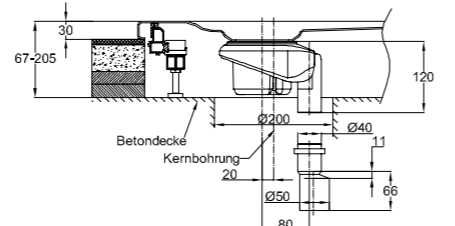
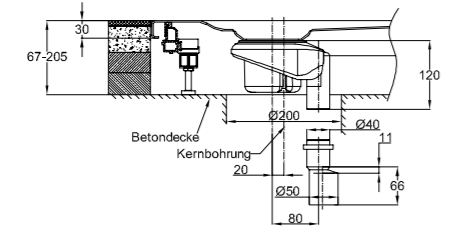

Schnittzeichnungen BetteUltra 35 mm mit Einbausystem Basic

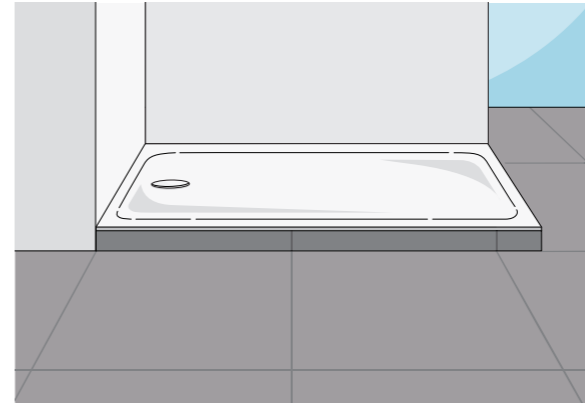
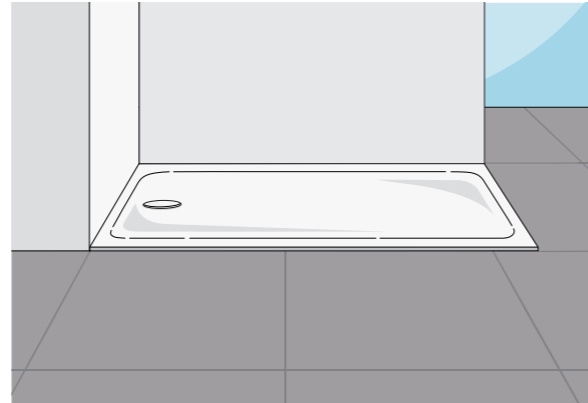
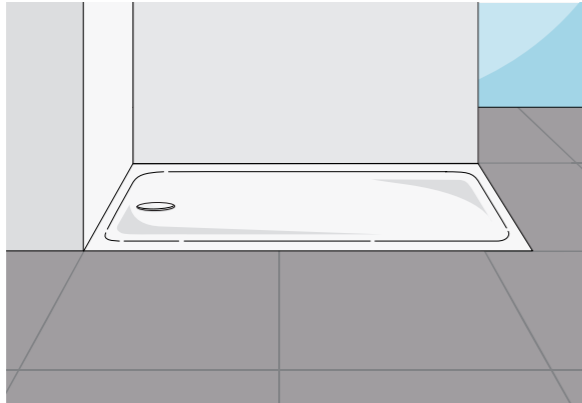

Ablaufgarnitur Bodengleicher Einbau

BetteSolid 50

B598-
0,6 l/s
mit seitlicher
Entwässerung,
Sperrwasserhöhe 50 mm
gem. EN 274

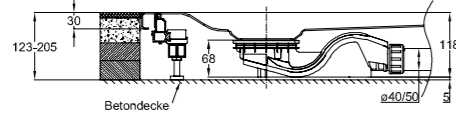

Nahezu bodengleicher Einbau

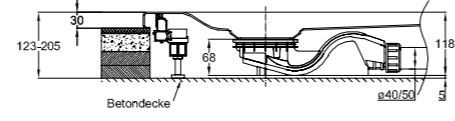

Einbau mit Fliesensockel aus dem Boden

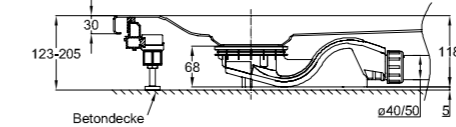

BetteSolid 30

B597-
0,6 l/s
mit seitlicher
Entwässerung,
Sperrwasserhöhe 30 mm
gem. EN 274

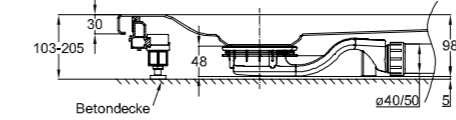
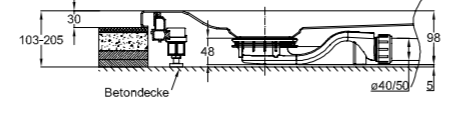
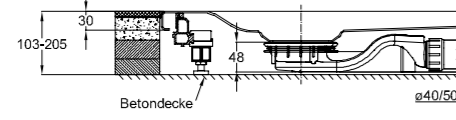

BetteScope

B574-
0,85 l/s
mit seitlicher
Entwässerung,
Sperrwasserhöhe 50 mm
gem. EN 274

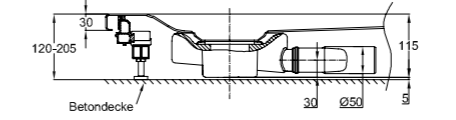
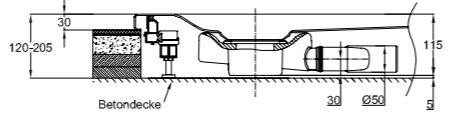
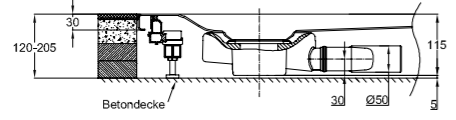

BetteDown

B594-
0,6 l/s
mit senkrechter
Entwässerung,
Sperrwasserhöhe 50 mm
gem. EN 274

